

PACIFIC HELMETS (NZ) LTD

PROTECTIVE HELMETS

- User Information Guide

All models are designed and manufactured in New Zealand by Pacific Helmets (NZ) Ltd

IMPORTANT NOTICE:

This User Information Guide is to be removed from the helmet only by the end user. Because this helmet may save your life or prevent serious injury, under no circumstances should it be dropped or carelessly used. Accidental damage may not be visible and in some instances may reduce the helmet's performance.

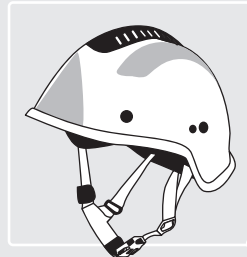
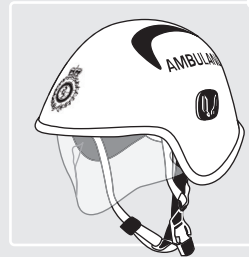
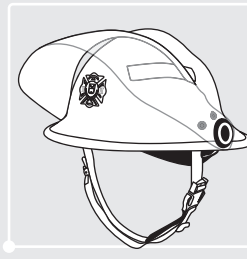
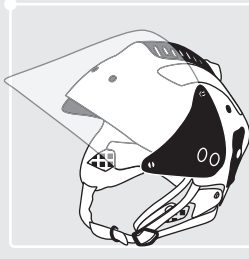
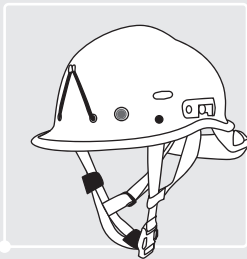

P. O. Box 866, 315 Heads Road,
Wanganui 4501, New Zealand
Phone: +64 -6- 344 5019
Fax: +64 -6- 344 5376
Email: sales@pacifichelmets.com
Website: www.pacifichelmets.com

1.	Introduction	1
2.	Essential Information Warnings	2
3.	General Pre-use Information a. Safety Considerations and Limitations of Use b. Recommended Storage Practices	3
4.	Preparation Information a. Fitting Your Helmet b. Wearing Instructions	6 9
5.	Care & Maintenance Information a. Inspection Details and Frequency b. Repair / Replace Instructions / Obsolescence	10 13
6.	Warranty Information	14
7.	Standards Information a. Fire Fighters Helmets AS/NZS4067: 2004 and 2012 b. Helmets for Fire Fighting, EN443: 2008, complies with the PPE Directive and Marine Equipment Directive – CE c. Occupational Protective Helmets AS/NZS 1801: 1997 (Type 1 - Industrial, Type 2 - Hot Work, Type 3 – Bushfire Fighting) d. Light Rescue and Industrial Helmets (EN 397: 2012) – CE e. Rescue/Light Duty Operations (ANSI Z89.1: 2009) f. Helmets for Mountaineers (EN 12492: 2012) – CE g. NFPA Standards h. Paramedic Helmet, complies with EU Council Directive 89/686/EEC and PACIFIC technical specification based on relevant EN443: 2008 clauses - CE i. CIT HELMET, model P10 approved to relevant NIJ 0104.02 & EN443:2008 clauses - CE j. Personal Eye-equipment Face Shields and Visors for use with Fire Fighting and High Performance Industrial Safety Helmets used by Firefighters, Ambulance and Emergency Services (EN14458: 2004) k. Eye Protectors EN166: 2001 Edition l. Personal Eye & Face Protection Device (ANSI Z87.1: 2010)	15
8.	Certification and Distributor Information a. Certification b. Authorised Distributors	29
9.	Supplementary Information	29



CONGRATULATIONS FOR PURCHASING A PACIFIC HELMET

1. INTRODUCTION

This guide addresses the Pacific range of helmets. Your new helmet incorporates materials and design ideas that are primarily intended to safely protect you from all foreseeable dangers and to give the best possible comfort, convenience and appearance that a modern protective helmet can provide depending on the standard. This helmet has been carefully engineered and manufactured to precise design and performance criteria. Our objective is to provide you with a safety helmet that is lightweight, comfortable, practical to use, incorporates the very best materials available and is built to the highest standards of workmanship. Your helmet is intended to provide protection to your head and portions of your face and neck as part of a properly selected and configured ensemble.

This document provides information and instructions related to the selection, use, care, and maintenance of your helmet. However, this document does not tell you when and under what circumstances you should wear your helmet. Rather, it suggests how to wear your helmet and provides an understanding of the limitations of your helmet in how it may or may not protect you. The responsibility for determining of the suitability of your helmet for specific emergency operations rests with your department or employer, who has the legal responsibility to conduct a hazard assessment and decide if your helmet provides appropriate protection against identified hazards.

Contained herein is basic information detailing how to adequately care for and maintain your helmet, but there are certain additional procedures – such as advanced inspection, advanced cleaning, decontamination, and retirement.

2. ESSENTIAL INFORMATION

Sections 3 and 4 provide essential and specific pre-use information and **MUST BE READ** before using the helmet.

Sections 5 and 6 provide cleaning and maintenance and warranty information.

Section 7 provides Standards-specific information.

Section 8 provides Certification Information and Authorised Distributors contact information.

Section 9 provides supplementary information on changing Sweatpads and Neck protectors.

WARNINGS



The helmet is designed to absorb shock by partial destruction of the shell and liner. This damage may not be visible. If subject to severe impact or deterioration, the helmet is to be returned to manufacturer for inspection, or replaced, even if it is apparently undamaged.



This helmet is not designed to provide protection from the following hazards: non-ionizing radiation, ionizing radiation and external radiation.



The safety intended to be provided by the helmet can only be ensured when it is properly assembled and correctly fitted, and that removable parts shall not be worn separately.



Safety intended to be provided by the helmet can only be ensured when it is properly assembled and correctly fitted, and that removable parts shall not be worn separately. For proper fitting of the helmet, please refer to FITTING THE HELMETS in Section 4 Preparation Information of this User Information Guide.



When fitted with another item of personal protective equipment or with an accessory (other than as supplied by Pacific Helmets (NZ) Ltd for use with this helmet), a helmet marked as complying with NIJ 0104.02 or EN443 might no longer satisfy all clauses of the standard.

a. SAFETY CONSIDERATIONS AND LIMITATIONS OF USE

It is critically important that you do not use your protective helmet until you have read and understood this entire guide and the labels provided on the interior of your protective helmet. In order to reduce – but not eliminate – your risks, do not wear this protective helmet **UNLESS THE FOLLOWING ARE UNDERSTOOD:**

i. The Labels, this Guide and Applicable Standards

You have read, fully understand, and strictly adhere to this guide, all labels for this helmet and applicable national, state/provincial and local regulations pertinent to emergency operations.

ii. Your Use is in Accordance with Applicable Standards and Regulations

Your use of the helmet is consistent with the relevant Standards and Regulations governing the applications in which the helmet is being used.

iii. Hazard/Risk Assessments already Conducted

Your department, organization, or employer has conducted a risk/hazard assessment and determined that this helmet provides an acceptable level of protection for the particular emergency operations consistent with applicable federal, state/provincial, and local regulations.

iv. Your Helmet is Properly Adjusted

Your helmet must fit or be adjusted to the size of your head. Where applicable, it also should be positioned to not interfere with your self-contained breathing apparatus (SCBA) face piece.

v. All Components of your Helmet are in Place and Properly Worn

Your helmet must be complete and you must wear your helmet properly. Where applicable, this includes the full deployment of your neck protector and the proper attachment and adjustment of your chinstrap for securing the helmet on your head.

vi. Limitations of Protection

That not all helmets provide heat and/or flame resistance or protection from all hazards, and you have been trained and understand how to select and properly use the appropriate helmet to meet the expected exposure.

vii. Risks of Heat Stress

It is possible that wearing your protective helmet together with other ensemble elements may increase your risk of heat stress, which may cause heart attack, stroke, dehydration, or other health-related conditions. At the first sign of heat stress, immediately seek medical help.

viii. Risks of Burn Injury

Protective fire fighting helmets will not protect you from all burns and injuries. If your fire fighting helmet is exposed to radiant, convective, or conductive heat, or comes in contact with a hot environment or hot object, you may be burned underneath the protective helmet with no warning and no sign of damage to the protective helmet.

ix. Possibility that Heat Sensation may be Absent

Be aware that your protective helmet will lower your ability to feel heat. Do not be misled by the absence of heat or discomfort underneath your protective helmet. Even though you do not feel heat or discomfort, you can be burned or injured suddenly and without warning. If you feel heat or some slight discomfort or unusual sensation under your protective helmet, you may already have been burned or are about to be burned. Be constantly alert to the possibility of exposure to heat and other hazards.

x. Areas with and without Barrier Protection

When fitted, most neck protectors are NOT equipped with a barrier material. Consequently, the fire helmet will provide only little to no liquid integrity to your head and face area. Also, your fire helmet may not protect you from all chemical, radiological, or biological hazards that can cause death, injuries, diseases, and illnesses. Furthermore, this helmet does not offer any protection from hazardous vapours or gases, liquefied gases, or cryogenic liquids. Ensure that you have a proper interface for your protective helmet with your protective coat, protective hood, and SCBA.

xi. Other Hazards

Your protective helmet, wet or dry, may not always offer protection from electrical shock. Your protective helmet will not protect you from all physical hazards. Falling heavy objects or impact with hard surfaces may cause forces that can be fatal or severely injure you. Do not use your protective helmet if it is contaminated, cut, punctured, worn, cracked, abraded, or altered from its original condition.

xii. The Need for a Complete Ensemble (especially when fighting fires)

Helmets are effective only when they are properly worn, where applicable, provide a proper interface with your garment, hood, and SCBA and are part of a complete ensemble. A complete ensemble includes appropriate elements for your overall protection and is consistent with your organization/department's hazard and risk assessment.

xiii. Proper Care and Maintenance

Helmets must be properly inspected, maintained, and cared for by your department, organization, or employer consistent with these instructions and applicable federal, state/provincial, and local regulations. It must be free of soiling, contamination, damage, and any alteration from its original condition that would compromise its protection. Damage and contamination of a helmet may warrant its disposal.

xiv. Replacement Procedures after Impact or High Heat Exposure

The helmets are made to absorb the energy of a blow by partial destruction or damage to the shell and/or suspension system. Even though such damage may not be readily apparent, you should replace your helmet if it is subjected to a severe impact or excessive heat.

xv. Warranty Terms

Helmets are NOT warranted to be fit for a particular purpose. Read carefully the “Warranty Information” in this guide. If labels in the helmet are missing or become unreadable, contact Pacific Helmets (NZ) Ltd for replacement label information.

xvi. Marking Recommendations and Modifications

Do not attempt to alter or modify your helmet. Do not paint or apply any materials to the exterior of the helmet that have not been approved by Pacific Helmets (NZ) Ltd. For identification purposes, you may mark your protective helmet on the interior using an indelible marker, if permitted by your department or organization. Do not write over or obscure information on the product label.

xvii. Testing and Assessment of Performance

Your protective helmet has been evaluated for a number of performance properties that are based on the respective Standard(s) for its certification. These properties include, but are not limited to, impact force resistance and deceleration, penetration resistance, heat and thermal shrinkage resistance, flame resistance, electrical insulation, retention system slippage, suspension system retention (on the head). Where required by the relevant Standard, helmets may also be checked for shell separation, label durability and legibility, corrosion resistance, and trim visibility. If you have questions, check with your department or organization, who in turn can contact Pacific Helmets (NZ) Ltd.

b. RECOMMENDED STORAGE PRACTICES

The rear hook on the back brim of the helmet, if provided, can be used to hang your helmet. Store your helmet only when it is clean, dry, and free of contamination. Storing wet helmets, particularly when the suspension and neck protectors are wet, will promote growth of mildew, fungus, bacteria, or other harmful substances that can lead to skin irritation, rashes, and potential diseases or illnesses. Wet conditions can also lead to deterioration of helmet textile materials. Keep helmets away from potential contaminants such as oils, greases, or other chemical substances. Store your helmet in a clean, ventilated area away from direct sunlight and away from tools or other sharp objects. Do not store your helmet with your personal belongings or in a personal living area. Do not store or transport your helmet in the window areas of apparatus and vehicles.

a. FITTING YOUR HELMET

The integrity, fit, and proper assembly of the helmet, suspension, and chinstrap must be checked before each use. Your safety depends upon the proper fit of your helmet and proper use of all features and components. When an SCBA face piece is in use, typically, helmets are adjusted so that the helmet is tilted approximately 5 degrees above a level horizontal plane to properly accommodate the face piece.

WARNINGS :

The safety intended to be provided by the helmet can only be ensured when it is properly assembled and correctly fitted, and that removable parts shall not be worn separately.

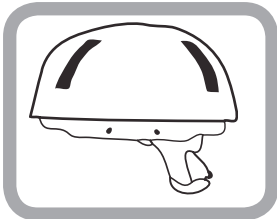

i. Helmets with full impact liners.

The complete impact liner is secured in the shell by either screws or Velcro or both. Liners should not be removed more often than is essential for special repairs, such as replacing the face shield and eye protectors.

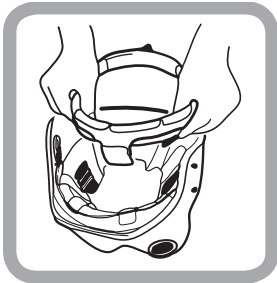

ii. Headband adjustment

The complete headband is secured inside the liner by three Velcroed legs. By adjusting the position of the Velcroed legs up and down (vertically) inside the liner, the lower edge of the headband should rest near the top of the wearer's ears. This will ensure the best lateral stability of the helmet. Downsize kits are available as optional extras, and can be fitted to the headband to adjust internal sizes. These may also assist prescription spectacle wearers to wear glasses with the face shield lowered.

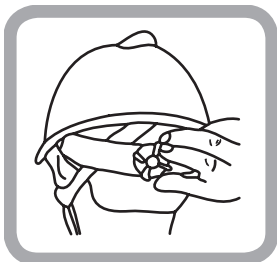

iii. Adjusting the size to fit your head:

Ratchet Adjustment: Rotate ratchet control knob to expand or contract band to provide comfortable but firm fit. A correctly adjusted helmet should fit the wearer's head without the chinstrap needing to be done up.

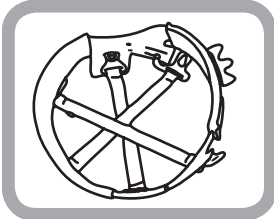

iv. Helmets with Cradle Systems only:

The cradle system clicks directly to the helmet shell and can be replaced when necessary. There are 2 height adjustments possible and size adjustment is identical to helmets with full impact liners.

v. Doing up the Chinstrap Securely (2-point Chinstraps):

Check the operation of the chinstrap buckle before putting the helmet on your head. When the buckle is closed both trigger arms on the female side must be depressed before the male side will withdraw.

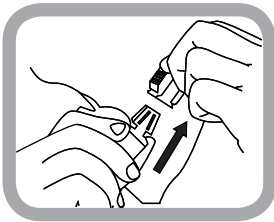

- Insert the buckle into the mating clip until both 'snap' together with a 'clicking' sound.

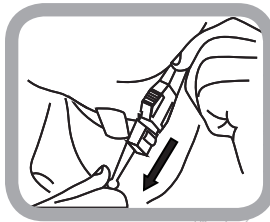

- Pull the free strap at the buckle end to desired tightness. Attach the loose end to the Velcro to store.



- If Postman Buckle fitted, pull the free strap at the buckle end to desired tightness. Attach the loose end to Velcro.

vi. Doing up the Chinstrap Securely (3-point Chinstraps):

If the helmet is fitted with a three point chin strap the nape strap connectors with the chin strap should rest under the ears and with the nape strap pulled tight. In this configuration the Pacific snap clip buckle will be located on the left hand side. Always keep the chinstrap done up during fire fighting operations or when travelling in fire trucks.

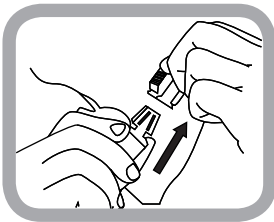

- Insert the buckle into the mating clip until it both 'snap' together with a 'clicking' sound.

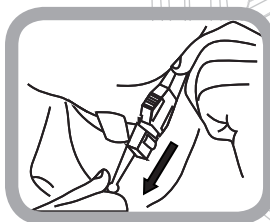

- Pull the free strap at the buckle end to desired tightness. Attach the loose end to the Velcro to store.

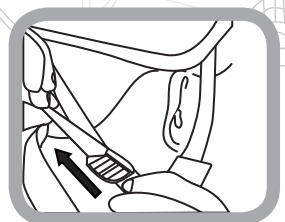

- For 3-point chinstrap, pull the nape adjustment strap behind the ear to desired tightness.

vii. Operational Instruction for One-Touch Eye Protector:



- STEPS :**
- Use the thumb to push the lower edge of the eye protector upward gently.
 - A 'clicking' sound can be heard and the eye protector will descend gradually from up position automatically;
 - To stow, use the thumb again and push the eye protector back up gently;
 - Stop pushing when the same 'clicking' sound is heard again. The eye protector is now locked in place.

- To adjust the eye protector height for a comfortable fit, follow the instruction below.

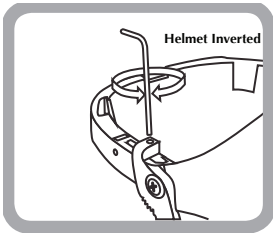

Turn, using the hex key provided, to adjust the resting position of the eye protector on the nose bridge.

The One-Touch Eye Protector is covered by PCT/NZ2009/000098 and other international patents pending.

- Eye Protector Safety Latch

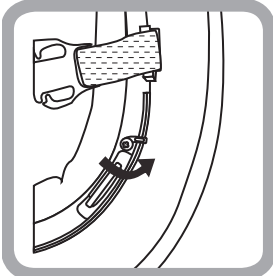

LOCKED Position :

Safety Latch extended out over the edge of the eye protector.



UNLOCKED Position :

The Safety Latch rotates away toward the inside of the helmet.

The Easi-on-off boss and Easi glide torch holder are covered by NZ and international patents.

viii. Fitting Instruction for Torch onto the Helmet.

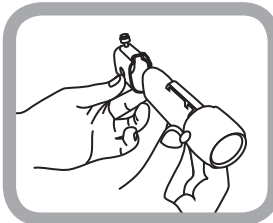

- Slide the torch body into the torch sleeve.

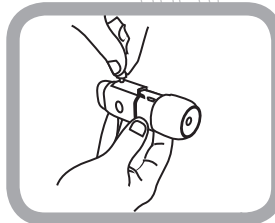

- Tighten the sleeve screw to secure the torch in place.

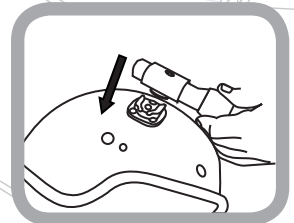

- Push the boss into the Easi-On-Off base tightly.

- ix.** Please contact your local distributor for details of the current part numbers.
Referencing to the primary reference (PRN#) inside your helmet and model (ID).

Replacing External Face shields and Hinges

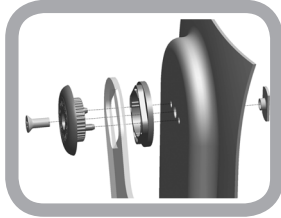

Replacing Internal Eye Protector

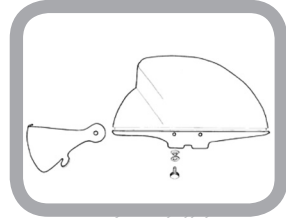

x. Details of accessories approved by manufacturer

Available replacement spare parts include the following	Available accessories include the following
Shell	A range of face shields and neck protectors
Trim-Lok shell brim extrusion	Helmet mounted radio headsets
Screws sets	Torches and helmet mounted torch clips
Headband cradle and ribbons	Downsize Kit to adjust sizes 50-56cms
Complete chinstrap	Carry Bags
Face Shield and hinge hardware	Reflective Trim
Neck Protector (Ear Flaps)	Hot Fire training thermal covers

b. WEARING INSTRUCTIONS

i. Donning

The following apply for properly putting on your helmet:

- Ensure the correct adjustment of your helmet as described in the previous section. The adjustment of your helmet should take into account if you will be wearing either a hood or an SCBA face piece or both.
- Place your adjusted helmet on your head and secure the chinstrap. Never wear your helmet without securing your chinstrap.
- Adjust all helmet, hood, SCBA, and coat components so that they provide a proper interface, with no gaps in protection occurring in any body position taken during use. You must deploy your neck protector completely to ensure overlap between your protective coat collar, protective hood, and SCBA face piece. If provided and when needed, ensure that your face shield or goggles are correctly deployed.

Check to make sure that your helmet, hood, and coat do not interfere with the seal of the SCBA face piece on your face.

ii. Doffing

If your protective helmet is not contaminated:

- Remove helmet in the reverse order from which you put it on.
- Inspect your helmet as indicated in the instructions above.

If your protective helmet is damaged, report this damage or other change in its condition to your supervisor or organization. Any damage or change in condition must be corrected before reusing your helmet. If your helmet has become contaminated with blood, body fluids, chemicals, or other hazardous substances, use protective gloves and extreme caution in removing your helmet, and do not contact the surface of your helmet with your bare hands. Seek assistance in removing your helmet and other parts of your ensemble to minimize your exposure to any contaminants.

5. CARE AND MAINTENANCE INFORMATION

a. INSPECTION DETAILS AND FREQUENCY

i. Routine Inspections

Inspect your protective helmet prior to its first use and following every use. Prior to using the helmet for the first time, ensure that the helmet does not have any construction flaws, is completely and properly assembled, and was not damaged when being put into service. Following every use, inspect your protective helmet for:

- Soiling
- Contamination
- Shell: physical damage such as cracks, dents, and abrasions
- Shell: thermal damage such as bubbling, soft spots, warping, and discoloration
- Neck protectors or headband covers: physical damage such as rips, tears, and cuts
- Neck protectors or headband covers: thermal damage such as charring, burn holes, and melting
- Neck protectors or headband covers: loss of seam integrity and broken or missing stitches
- Suspension and retention systems: damaged or missing components
- Face shield/eye protector system: Damaged or missing components, including discoloration or scratches to the face shield or eye protector, limiting visibility
- Reflective trim or visibility markings: Damaged or missing pieces

If these conditions exist, alert your supervisor of your department or organization to make a determination on the continued serviceability of your protective helmet.

ii. Annual Inspections

Your protective helmet is recommended to be subjected to a more thorough inspection at least every 12 months, after every advanced cleaning, or whenever there is a concern about its condition for continued service.

iii. Importance of Clean and Well Maintained Helmets

It is important that you keep your protective helmet clean, free of contamination, and properly maintained at all times. Protective helmets that are dirty or contaminated pose significant hazards. Many contaminants can be absorbed by the skin, and some are carcinogenic. In addition, many contaminants are flammable. Do not wear your protective helmet unless it is properly cleaned and thoroughly dried.

Refer to the relevant Standard for the Selection, Care, and Maintenance of the helmet for additional guidance. However, the instructions provided by Pacific Helmets (NZ) Ltd take precedence over any requirements specified in the relevant Standard.

iv. Cleaning Precautions

In cleaning your protective helmet:

- Use only mild detergents with a pH range of not less than 6.0 pH and not greater than 10.5 pH as indicated on the product material safety data sheet (MSDS) or original product container.
- Substances recommended for cleaning, maintenance or disinfection shall have no adverse effect on the helmet and shall not be known to have any adverse effect upon the wearer when applied in accordance with the manufacturer's instructions.
- Never use solvents or chlorine bleach or cleaning agents that contain chlorine bleach. These substances rapidly break down some helmet materials.
- Do not machine wash or dry whole helmets. The neck protectors and headband/ratchet covers may be machine washed and dried as instructed below.
- Separately clean helmet neck protectors.
- Do not use wash water or drying temperatures above 40°C.
- Wear protective gloves and eye/face splash protection when cleaning soiled items.
- Do not wash protective helmet or other protective clothing alongside personal items.
- Do not dry clean your protective helmet or helmet components.

v. Routine Cleaning

Clean your protective helmet after each use or whenever your helmet has become soiled. You may clean your helmet with or without the neck protector, headband/ratchet covers, and chinstrap. Use the following procedures for routine cleaning by hand of your protective helmet in a utility sink:

- Choose a utility sink that is specifically used for cleaning protective gear; do not use a kitchen sink or other sink that is employed for personal products.
- Remove the neck protectors and chinstraps and wash separately using the instructions provided below.
- Brush off any loose debris.
- Fill the utility sink with warm water no hotter than 40°C.
- Use a mild detergent in an amount according to the detergent supplier's instructions.

- Scrub the exterior of the helmet gently using a soft bristle brush.
- Only use a soft cloth or sponge to clean the eye protector/face shield.
- Drain the sink and thoroughly rinse the exterior of the helmet. Conduct a second rinse if necessary.
- Inspect the helmet and, where necessary, rewash any portions of the protective helmet that do not appear clean, or submit it for advanced cleaning.
- Dry the helmet by air drying it in a well ventilated area, but not in direct sunlight. Do not force dry the helmet with a hair dryer, or place it over a heating duct or radiator. Forced drying may cause damage to the helmet suspension.
- Only when all components are dry, reinstall the neck protector and headband/ratchet pads.
- Rinse the utility sink, following routine cleaning procedures.

vi. Decontamination

Proper decontamination of your protective helmet will depend on the type and extent of contamination. If your protective helmet has become contaminated with blood or body fluids, immediately isolate the helmet and inform your supervisor, department, or organization. Before reuse of your protective helmet, it must be subjected to specialized cleaning procedures that have been proven to remove contaminated fluids.

If your protective helmet has become contaminated with chemicals or other hazardous substances, immediately isolate your helmet and remove it from service, taking care not to cross-contaminate other clothing items. Immediately inform your supervisor, department, or organization. Do not wear a helmet that was contaminated until verification has been provided that it is free from contamination.

vii. Removal and Installation of Components

In most cases, your protective helmet will be provided fully assembled. However, there are some cases where you will need to install certain components, or you may need to replace some components that have become damaged. You will also need to remove the neck protector for complete cleaning of your helmet.

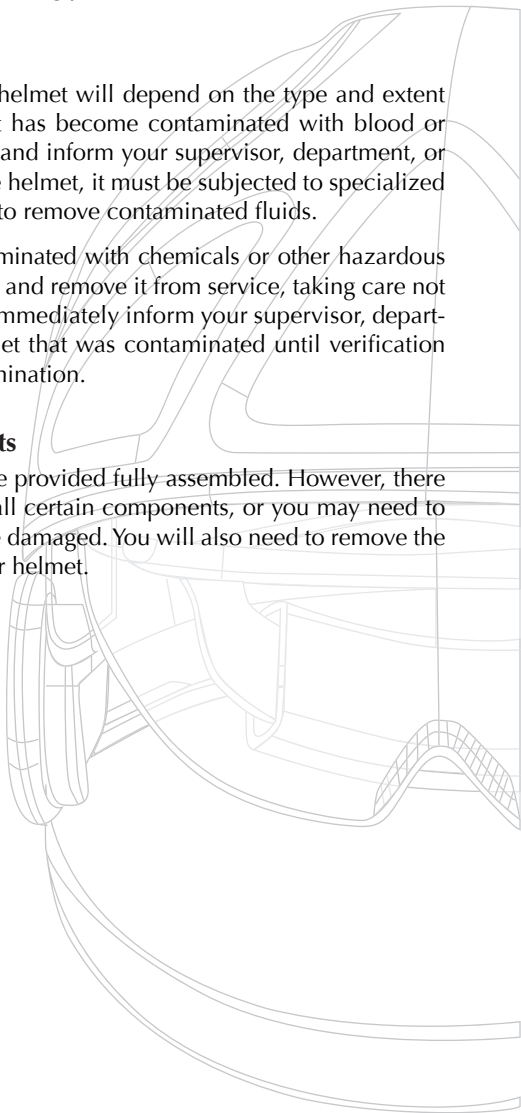

b. REPAIR / REPLACE INSTRUCTIONS / OBSOLESCENCE

Note: Minor scratches or cracks in the paint surface will not affect the performance of the helmet.

- **Repair if:**

- The shell is permanently stained by carbon or chemicals
- The painted surface slightly scratched
- There is surface damage only

In these cases the shell can be restored to use by warm wet sanding to remove the stains, scratches and surface damage.

- **Destroy the shell and replace if:**

- The shell shows signs of major laminate failure/breakage. This will either take the form of deep indentations from falling objects or major crushing. It can also be seen as a 'whitening' of laminate in impact area when the inside of the shell is inspected.
- The brim area has severe crack lines or flexes abnormally.
- The helmet has obviously suffered excessive heat or burning. This includes any charring of the paint or helmet substrate. Charring is described as an actual burnt area or surface damage, which cannot be repaired by sanding or repainting.
- There is visual sign of acid or chemical residue which may damage the shell paint or substrate.
- The shell shows signs of distortion to its shape. This can be seen as 'sagging' or 'drooping' when it is compared to a new helmet. This type of damage is most unlikely in the Pacific helmet shell, as the shell does not melt, even in extreme temperatures.

If you have any doubts about your protective helmet and its condition, bring this matter to the attention of your supervisor, department, or organization immediately. Protective helmets that are no longer deemed serviceable for reasons of damage, contamination, or other unsafe condition must be disposed of in a fashion whereby the helmet cannot be reused. One example is drilling holes in the shell, removing the chinstrap and suspension, and damaging the tabs for attaching the headband.

For general disposal of helmets, use landfills, incineration and/or other facilities that are in accordance with municipal guidelines/regulations.

Contaminated helmets must be disposed of by your department or organization in accordance with federal, state, or local regulations.

Please contact your local distributor for details of the current part numbers referencing to the primary reference (PRN#) inside your helmet and model (ID).

◆ 6. WARRANTY INFORMATION ◆

Warranties cover only faulty materials or workmanship. Fair wear and tear resulting from normal use is excluded. The Manufacturer (or his agent) shall be the sole arbiter of all warranty claims

The warranty time limits mentioned herein **do not imply any form of helmet life expectancy**. These time frames simply place reasonable limits on the discovery of faulty materials and workmanship and allow these to be dealt with.

The products and the relevant sub-components are supplied with varying warranties (depending on the model) for 1-6 years.

- **SHELLS**

Up to 6-year warranty.

- **EAR FLAPS / NECK PROTECTORS**

Up to 1-year warranty. We recommend they be replaced after a maximum of 50 wash cycles.

- **FACE SHIELD / EYE PROTECTORS**

Up to 2-year warranty. Replace once scratched or deformed by chemicals, heat, smoke or other pollutants.

- **INTERNAL PLASTIC COMPONENTS AND COMFORT PADDING**

Up to 1-year warranty.

COMPONENTS

- Damage caused to the helmet and/or components in the course of normal use is not covered by warranty.
- Many recreational, public order, fire fighting or rescue operations including training can result in damage to this equipment, which is not covered by this warranty.
- Damage resulting from careless use (e.g. dropping of helmet) and/or using helmet for anything other than its intended purpose (head protection) is not covered by warranty.
- Training personnel involved in repetitive hot fire training will require their helmets to be replaced at frequent intervals certainly no longer than one year. This is dependent on the duration, frequency and exposure to heat and pollutants.
- All personnel involved in hot fire training and proximity fire fighting (or training) must wear their helmets with aluminized hoods over the shells when engaged in these activities.
- Follow instructions in the User Information Guide regarding regular checks on this helmet and when making repair/replace decisions.
- Components are available as spare parts.

a. FIRE FIGHTERS HELMETS AS/NZS4067: 2004 & 2012

No helmet can protect the wearer against all possible types of impacts.

- Do not modify or remove parts or add accessories which are not approved by the manufacturer. Replace harness and other components as recommended by manufacturer.
- Helmet and face shield may be seriously damaged by certain substances, Manufacturer's instructions should be followed for cleaning and maintenance. Refer to Section 5, Cleaning and Maintenance Instructions.
- This helmet must be properly adjusted and secured to the head, with all components in place, to provide the designed level of protection.
- For maximum retention, the helmet must fit firmly on the head, and all retention straps must be securely fastened.
- No attachments should be added nor any alterations made to the helmet except those recommended by the helmet manufacturer.
- If replacement of any components of the harness is necessary, the complete harness should be replaced.

b. HELMETS FOR FIRE FIGHTING, EN443: 2008, COMPLIES WITH THE PPE DIRECTIVE AND MARINE EQUIPMENT DIRECTIVE – CE

i. Helmet Models:

The Pacific helmet models covered by this document are the F3, F7 and F10.

ii. Explanation of the Symbols shown on Labels fitted inside the Helmets.

Year of manufacture
Surface insulation test
Resistance to liquid chemical
Low temperature classification –30°C

e.g. 15 (2015)
E3
C

iii. Instructions or Recommendations

- **Size selection:**

All helmets are adjustable to sizes between 52-64cm, with downsize padding kits available to adjust sizes between 52-56cm.

- **Mass:**

Fire fighting and paramedic helmets may vary in weight depending on models, specifications and accessories but will typically be between 1.1-1.6 kg.

- **Use:**

Helmets are designed for Structural fire fighting in both land and marine environments.

- **Cleaning and disinfection**

Refer to Section 5, Care and Maintenance Information.

- **Maintenance and servicing**

Refer to Section 5, Care and Maintenance Information.

- **Storage and transportation**

Store helmet in dry ambient conditions when not in use. For marine use, keep the helmet dry and away from moisture or liquid like seawater that may deteriorate the components prematurely. Always keep the helmet in its carry bag.

- **Obsolescence**

The helmet can be expected to remain in service for up to 25 years, when it is not damaged during use.

- **Inspections (especially applicable to the Marine Equipment Directive)**

Helmets are to be inspected at least monthly, or according to the interval defined by each vessel. On most merchant ships this should take place during routine fire and/or emergency drills. Check the exterior and cradle of the helmet for wear and tear, rust, or any signs of deterioration. If in doubt, please go to sub-section (b) Repair/Replace Instructions/Obsolescence under section 5, (a,b) and maintenance information.

iv. The length of the useable life of this helmet will be affected by the type(s) of material used in its construction and the environments in which the helmet is used and stored. Recommendations on this topic should be sought from Pacific Helmets (NZ) Ltd.

v. Details of additional approved accessory devices can be provided. This includes Easi On/Off Bases, torches, torch clips, face shields, eye protectors, and neck protectors.

vi. WARNING: The safety intended to be provided by the helmet can only be ensured when it is properly assembled and correctly fitted. Removable parts shall not be worn separately.

vii. WARNING: When fitted with another item of personal protective equipment or with an accessory, (other than as supplied by the helmet manufacturer for use with this helmet) a helmet marked as complying with EN443 may no longer satisfy all clauses of the standard. Refer to information supplied by Pacific Helmets (NZ) Ltd.

viii. List of chemicals against which the helmet has been tested.

- 30% Sulphuric Acid, 10% Sodium Hydroxide, p-Xylene, Butan-1-ol, n-Heptane.
- This helmet complies with the retention requirements of this standard when the chinstrap supplied by the helmet manufacturer is worn and adjusted in accordance with these instructions.
- This helmet absorbs the energy of a blow by partial destruction of, or damage to, the helmet. Even though such damage may not be readily apparent, any helmet subjected to a severe impact should be replaced.

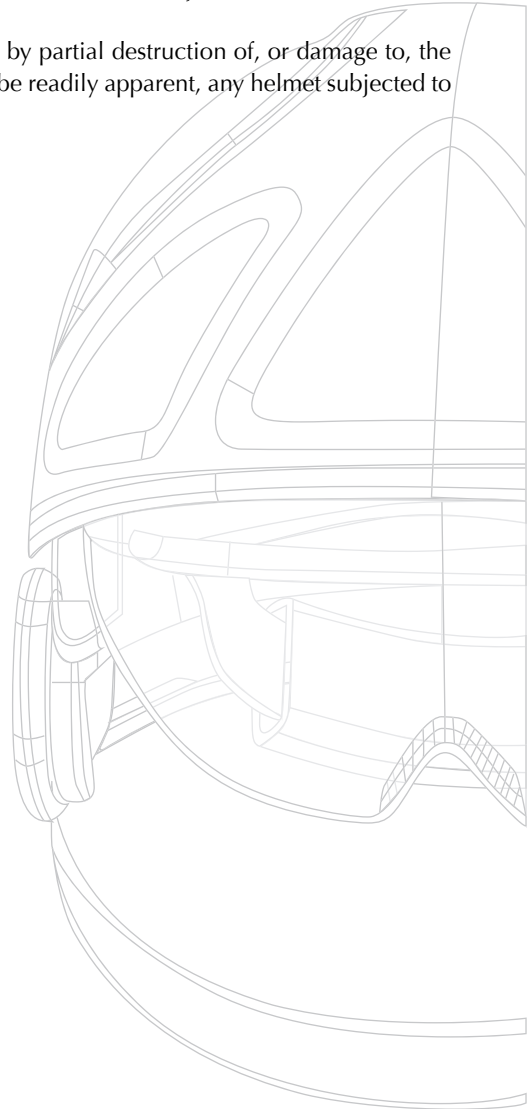

c. OCCUPATIONAL PROTECTIVE HELMETS AS/NZS 1801: 1997 (TYPE 1 - INDUSTRIAL, TYPE 2 - HOT WORK, TYPE 3 – BUSHFIRE FIGHTING)

- No helmet can protect the wearer against all possible impacts. For maximum protection, the helmet must fit firmly on the head, and all retention straps must be securely fastened.
- No attachments should be added or alterations made to the helmet except those recommended by the helmet manufacturer. The helmet is designed to absorb shock by partial destruction of the shell and liner.
- This damage may not be visible. Therefore if subjected to a severe blow, the helmet should be returned to the manufacturer for inspection or replaced, even if it is apparently undamaged.
- The helmet may be damaged and rendered ineffective by such materials as petroleum and petroleum products, cleaning agents, paints and adhesives, without the damage being visible to the user.
- For the list of suitable cleaning agents that can be applied to the helmet and face shield, please refer to Section 5, Care and Maintenance Information.
- If in doubt, please contact the helmet supplier.

i. AS/NZS 1801 Type 3 Bushfire

- Type 3 bushfire helmets must be fitted with chinstraps and a minimum area of reflective trim.
- Neck protectors are recommended but optional.
- Chinstraps should be done up at all times.

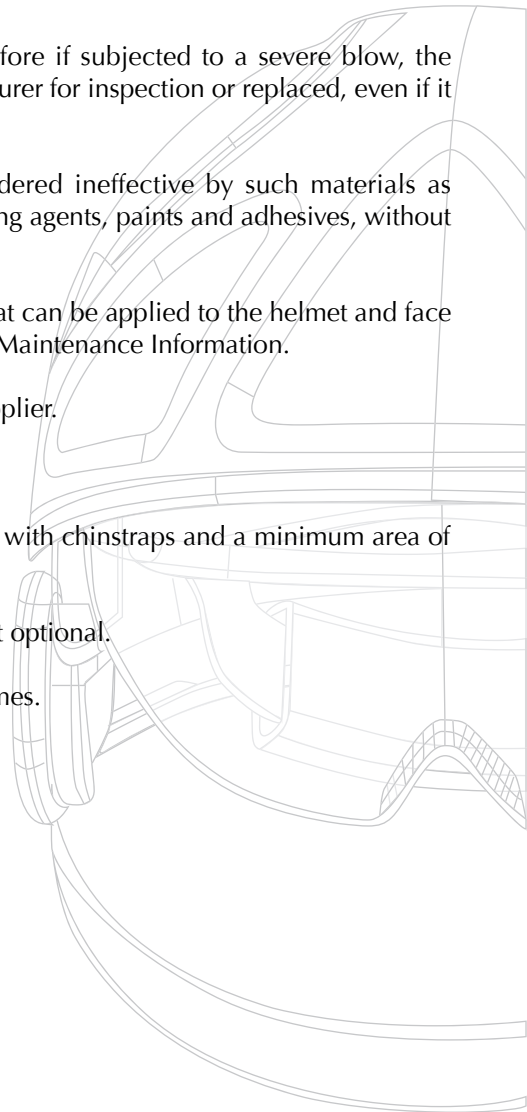

d. LIGHT RESCUE AND INDUSTRIAL HELMETS (EN 397: 2012) – CE

i. Classes of Protection

The protection provided by the helmet makes it suitable for light industrial type head protection where top of head protection is required. Side impact protection is limited. Not suitable for motorized or other methods of transport.

ii. Size and fitting adjustments

Head sizes between 52-64 cm will normally be adjustable by rotating the nape ratchet. Smaller head sizes may require a downsizing kit. For smaller head sizes, the position of the headband can be adjusted by changing the linking straphangers, which position the headband in four positions inside the helmet. Adjust the chinstrap and nape strap to firmly secure the helmet on the head by moving the positions of the buckles on their relative positions on the strap webbing.

iii. Cleaning and disinfecting

Refer to general Section 5, Care and Maintenance Information.

iv. Obsolescence

The helmet can be expected to remain in service for 5 years or more, when it is not damaged during use. The face shield is replaceable and replacement will be necessary if it is damaged during use, e.g. if badly scratched or if vision is obscured. Replace other subcomponents such as sweat pads where necessary.

v. Use

This helmet is recommended for light industrial, light rescue, paramedic, water rescue or rural non-structural fire fighting.

vi. Accessory Requirements

There are no accessory requirements.

vii. Packaging

The helmet must be delivered in packaging supplied by the manufacturer. All helmets are available with poly-bags.

viii. Spare Parts

We recommend only the sweatpads, front and rear, are replaced. These are available in both Merino wool, synthetic or leather material. Any other changes are considered structural – NO STRUCTURAL CHANGE MUST BE ATTEMPTED without prior consultation of the manufacturer or the manufacturer's authorised distributors.

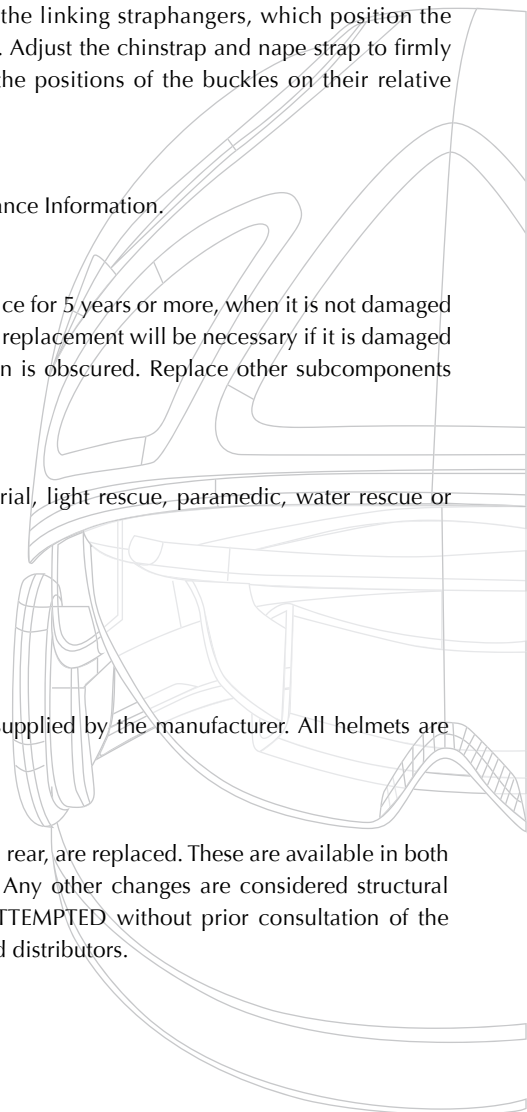

e. RESCUE/LIGHT DUTY OPERATIONS (ANSI Z89.1: 2009)

- The helmet is designed for use in Light Duty Rescue, some Industrial and Bushfire applications.
- Users are cautioned that if unusual conditions prevail (for example higher or lower extremes of temperature than those described), or if there are signs of abuse or damage to the helmet or of any component, the degree of protection may be reduced. Any helmet that has received an impact should be removed from service, since the impact may have substantially reduced the protection offered.

f. HELMETS FOR MOUNTAINEERS (EN 12492: 2012 editions) – CE

i. Classes of Protection

The protection provided by the helmet makes it suitable for mountaineering and climbing type head protection where top of head protection is required. Side impact protection is provided. Not suitable for motorized or other methods of transport.

ii. Size and Fitting Adjustments

Head sizes between 52-64 cm will normally be adjustable by rotating the nape ratchet. Smaller head sizes may require a downsizing kit. For smaller head sizes, the position of the headband can be adjusted by changing the linking straphangers, which position the headband in four positions inside the helmet. Adjust the chinstrap and nape strap to firmly secure the helmet on the head by moving the positions of the buckles on their relative positions on the strap webbing.

iii. Cleaning and Disinfecting

Refer to general Section 5, Care and Maintenance Information.

iv. Obsolescence

The helmet can be expected to remain in service for 5 years or more, when it is not damaged during use. Almost all components are replaceable and replacement will be necessary if it is damaged during use, e.g., if face shield is badly scratched or if vision is obscured. Replace other subcomponents such as sweat pads where necessary. Consult page 13.

v. Use

This helmet is recommended for mountaineering, paramedic, light industrial, light rescue, water rescue, or rural non-structural fire fighting.

vi. Accessory Requirements

There are no accessory requirements.

vii. Packaging

The helmet must be delivered in packaging supplied by the manufacturer. All helmets are available with poly-bags.

viii. Spare Parts

We recommend only the sweatpads, front and rear, are replaced. These are available in both Merino and leather material. Any other changes are considered structural – NO STRUCTURAL CHANGE MUST BE ATTEMPTED without prior consultation of the manufacturer or the manufacturer's authorised representative.

g. NFPA STANDARDS

- i. **Structural and Proximity Fire Fighting Helmets - NFPA 1971: 2013 edition**
- ii. **Wildland Fire Fighting NFPA 1977: 2011 edition**
- iii. **Technical Rescue Operations NFPA 1951: 2013 edition**

Safety considerations

- No helmet can protect the wearer against all possible types of impacts. The capacity of the helmets designed level of protection could be exceeded in some foreseeable perilous emergency services incidents.
- For maximum protection, the helmet must fit firmly on the head and all retention straps must be securely fastened.
- No attachments should be added or alterations made to the helmet except those recommended by the helmet manufacturer. Do not remove parts from the helmet without replacing them with genuine replacements.
- The helmet is designed to absorb shock by partial destruction of the shell and liner. This damage may not be visible. Therefore, if subjected to a severe blow, the helmet should be returned to the fire department equipment service centre or your local helmet distributor for inspection or replacement.

Helmet marking recommendations and restrictions

Subject to the restrictions on modification or drilling holes, most self-adhesive labels and other forms of external marking can be applied to the shell.

Performance properties and precautions

The helmet user is cautioned that most of the performance properties of the helmet cannot be safely tested by the user in the field. Because helmets can be damaged, they should not be abused. They should be kept free from abrasions, nicks and should not be dropped, thrown, or used as supports. This applies especially to helmets that are intended to afford protection against electrical hazards.

Proper use consistent with NFPA 1500, Standard on Fire Department Occupational Safety and Health Program, and 29 CFR 1910.132, "Personal Protective Equipment".

Limitations of use

NFPA1971 : 2013 edition, Structural and Proximity Fire Fighting Helmets

These helmets are designed for use in general urban/ military fire fighting and rescue/ paramedic operations.

NFPA1977 : 2011 edition, Wildland Fire Fighting Helmets

These helmets are designed for use in general wildland fire fighting. (Not recommended for structural fire fighting which requires a brim on the helmet to provide additional thermal protection to the face and neck).

NFPA1951 : 2013 edition, Technical Rescue Operations Helmets

These helmets are designed for use in general urban/ military/ police rescue and paramedic operations.(Not recommended for structural fire fighting which requires a brim on the helmet to provide additional thermal protection to the face and neck).

There are three types of helmets are classified under these Standards:

Search operations - Utility protective helmets.

Technical rescue operations – Rescue and recovery protective helmets.

CBRN Technical Protective – Chemical, biological, radiological, nuclear protection helmets.

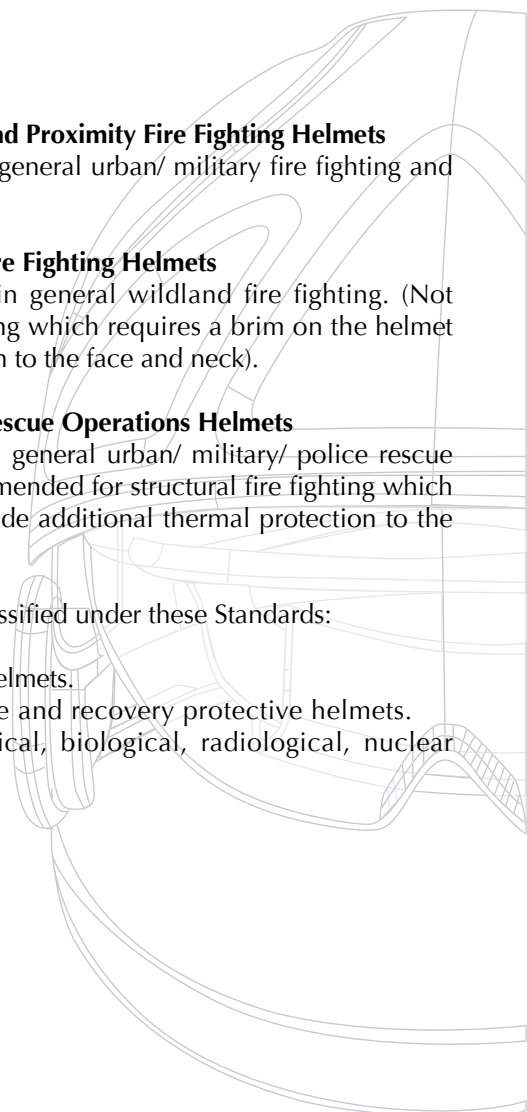

h. PARAMEDIC HELMET, COMPLIES WITH EU COUNCIL DIRECTIVE 89/686/EEC AND PACIFIC TECHNICAL SPECIFICATION BASED ON RELEVANT EN443: 2008 CLAUSES - CE

i. Classes of Protection

The protection provided by the helmet makes it suitable for paramedic personnel head protection where top of head and side impact protection are required, but not resistance to penetration. This helmet is not designed for fire fighting use, but suitable for users travelling in vehicles responding to emergency call outs.

PACIFIC Paramedic helmet models A7A and A10 have been tested to and met with the requirements of the following European Harmonized Standards:

• General requirement	EN443:2008 (clause 4.1)
• Shock absorption (Conditioned at -30°C)	EN443:2008 (clause 4.2, Area 1a & 1b)
• Lateral crushing	EN443:2008 (clause 4.4)
• Retention system effectiveness	EN443:2008 (clause 4.5)
• Retention system strength	EN443:2008 (clause 4.6)
• Field of vision	EN443:2008 (clause 4.14)
• Extend of protection	EN443:2008 (clause 4.15.1, areas 1a & 1b)

The face shield for model A7A is approved to EN166:2001 with the following classification:

- High speed particle, class A (at 190m/s)
- Optical class 2.

The eye protector for model A10 is approved to EN166:2001 with the following classification:

- High speed particle, class F (at 45m/s)
- Optical class 2.

i. CIT HELMET, MODEL P10 APPROVED TO RELEVANT NIJ 0104.02 & EN443:2008 CLAUSES - CE

i. Classes of Protection

This helmet has been designed and constructed to comply with the relevant clauses taken from NIJ 0104.02, EN443 and EN166 standards, and type-examined to fulfil the requirements of Annex II of Directive 89/686/EEC of the Personal Protective Equipment.

The protection provided by the helmet makes it suitable for private security personnel's head protection where top of head and side impact protection are required, as well as resistance to penetration. This helmet is not designed for fire fighting or where there are risks of ballistic penetration.

PACIFIC CIT helmet P10 has been tested to and met the requirements of the following Standards:

• Impact attenuation	NIJ 0104.02 (section 4.1.6)
• Penetration resistance	NIJ 0104.02 (section 4.1.7), at reduced height of 1m.
• Lateral crushing	EN443:2008 (clause 4.4)
• Retention system effectiveness	EN443:2008 (clause 4.5)
• Retention system strength	EN443:2008 (clause 4.6)
• Field of vision	EN443:2008 (clause 4.14)
• Extend of protection	EN443:2008 (clause 4.15.1, areas 1a & 1b)

The eye guard is also approved to EN166:2001 with the following classification:

1. High speed particle, class B (at 120m/s)
2. Optical class 2.

Note: NIJ 0104.02, is the standard for riot helmets developed by National Institute of Justice (NIJ), U.S. Department of Justice.

j. PERSONAL EYE-EQUIPMENT- FACE SHIELDS AND VISORS FOR USE WITH FIREFIGHTING AND HIGH PERFORMANCE INDUSTRIAL SAFETY HELMETS USED BY FIREFIGHTERS, AMBULANCE AND EMERGENCY SERVICES (EN14458: 2004)

The standard requires the following statements to be detailed.

a	Refer helmet labels or to the front page or this booklet.	b	EN14458: 2004.
c	Replacement Eye Guard part numbers are embossed on your eye guard.	d	Do not remove from helmet. Use only when helmet mounted on head. Replace when scratched or damaged. STORAGE –refer to page EN 443 – 2008 storage instructions section 3(b). USE – Visors for use with firefighters’ helmets mark with symbol. “(+)” in section 1 below). MAINTENANCE – refer to section 5. Criteria for recognizing when to replace components –Inspect after use and follow general inspection on section 5(b).
e	Refer to section (5) for instructions for cleaning and disinfections.	f	Eye Guard is designed to protect the face from some impacts, sparks, flames some chemicals (see section h and l below) and heat. Provides limited protection to the eyes from small particles.
g	Extremes of temperature at which performance has been tested. a) +120°C ± 5° b) -30 °C ± 2° c) Water at +10°C ± 2° d) +120°C ± 5 ° e) +20°C ± 5 ° at relative humidity 65% ± 5	h	Sulphuric Acid 30% Sodium Hydroxide 10% p-Xylene Butan-1-ol n-Heptane
i	Refer to page 8 for instructions as to fitting eye guard and other subcomponent assessors. There are no additional accessories necessary for these eye guards.	j	OBSOLESCENCE DEADLINE: 20 years or more if stored away from direct sunlight and indoors in dry ambient conditions.
k	TYPE OF PACKAGING REQUIRED: Not Applicable.	l	EN 14458: 2004 Pacific Helmets (NZ) Ltd B2055790 (+) for fire fighters Use ⊙ for an eye guard, or ⊕ for a face shield -30°C degrees, +120°C degrees -AT- Resistance to high energy impact at extremes of temperature -K- resistance to abrasion -Ω- for electrical properties ☒ User information in booklet 11 – Year of manufacture shown as 2 digits e.g. 11 = 2011
m	WARNING: The user should ensure the correct type of visor is fitted to their helmet for their intended activity. For structural fire fighting use an EN443 helmet with a visor marked “+”. WARNING: Users should note that the levels of protection are only provided when the visor is fully in the “in use” position.	n	WARNING: Visor / face shields oculars marked with ‘A’ (resistance to high energy impact) or ‘AT’ will only provide this level of protection if used with the designated helmets detailed above.

o

WARNING: Some materials that come into contact with the wearer's skin could cause allergic reactions to susceptible individuals.

q

WARNING: That visors worn over non-designated corrective frames may transmit impacts, which may damage the corrective eyewear thus creating a hazard to the wearer.

s

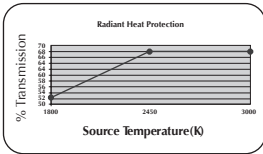

The radiant heat protection provided by this visor varies with the temperature of the heat source as shown in this graph. The visor should only be used in situations where it can reduce the exposure of the wearer's eyes to below 100 W/m².

p

WARNING: Replace when scratched or damaged.

r

WARNING: equipment not marked with 'T' should only be used at non-extreme ambient temperatures.

t

Not applicable, mesh face shields are not available.

u

Abrasion resistance testing was performed using the 'Resistance to surface damage by fine particles' method.

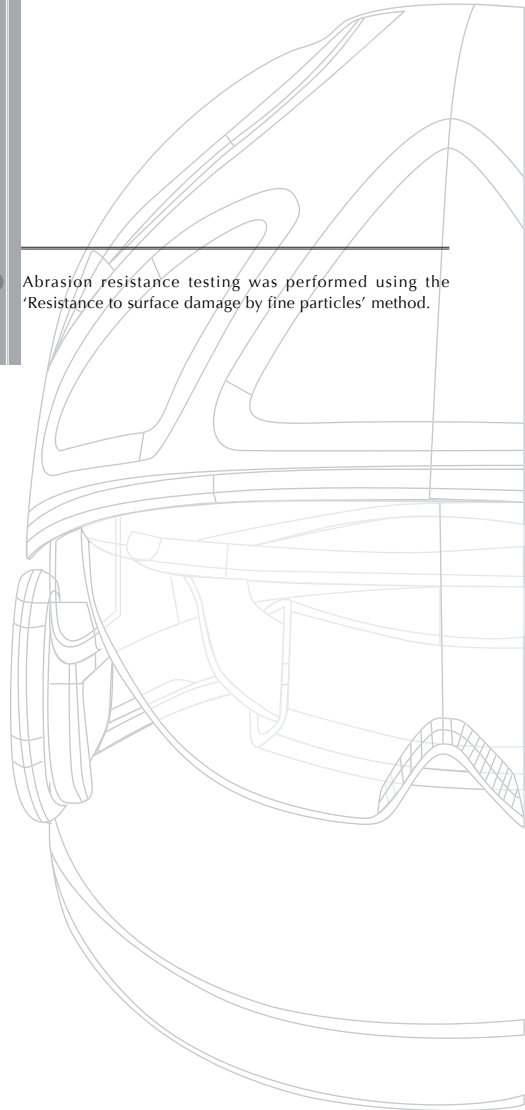

k. EYE PROTECTORS EN166: 2001 EDITION

Description

1.5mm Eye Protector

a	Name and address of the manufacturer.	Refer helmet labels.
b	The number of the standard.	EN166:2001.
c	Replacement Eye Guard part numbers are embossed on your eye guard.	
d	Instructions for storage, use and maintenance.	Refer to instructions, page 5-13.
e	Specific instructions for cleaning and disinfections.	Clean with water and dry with a soft cloth. Never use petroleum solvents for cleaning or disinfecting.
f	Details of the field of use, protection capabilities and performance characteristics.	For eye protection only, not for fire fighting but suitable when using rescue tools.
g	Details of suitable accessories and spare parts. Instructions for fitting shall be included with the original eye-protector and/or with the spare part or accessory.	Fitting and replacement instructions are provided in section 4.
h	The obsolescence deadline or period of obsolescence, if applicable, for the complete eye-protector and/or component parts.	20 years if stored away from direct sunlight and indoors in ambient conditions.
i	The type of packaging suitable for transport, if applicable.	N.A.
j	The significance of the marking on the frame and the ocular.	P = Pacific 2 = Optical Class B = Medium Strength 9 = Protection against molten metals/hot solids Year of manufacture shown as 2 digit e.g. 08 = 2008.
k	A warning that optical class 3 oculars are not intended for long term use, if applicable.	N.A.
l	A warning concerning the compatibility of marking (see notes (4), (5) and (6) to Table 12).	Users should note that this component provides protection for the eyes only.
m	A warning that materials which may come into contact with the wearer's skin could cause allergic reactions to susceptible individuals).	Warning some materials that come into contact with the wearer's skin could cause allergic reactions to susceptible individuals.
n	A warning that scratched or damaged oculars should be replaced.	Replace when scratched or damaged.
o	A Warning that eye-protectors against high speed particles worn over standard ophthalmic spectacles may transmit impacts, thus creating a hazard to the wearer.	
p	If protection against high speed particles at extremes of temperature is required then the selected eye-protector should be marked with the letter T immediately after the impact letter (i.e. FT, BT or AT. If the impact letter is not followed by the letter T then the eye protector shall only be used against high speed particles at room temperature).	

I. PERSONAL EYE & FACE PROTECTION DEVICE (ANSI Z87.1: 2010)

MARKING EXPLAINED

Z87 + means the device meets or exceeds high impact testing requirement.

Light means the device luminous transmittance exceeds 50%.

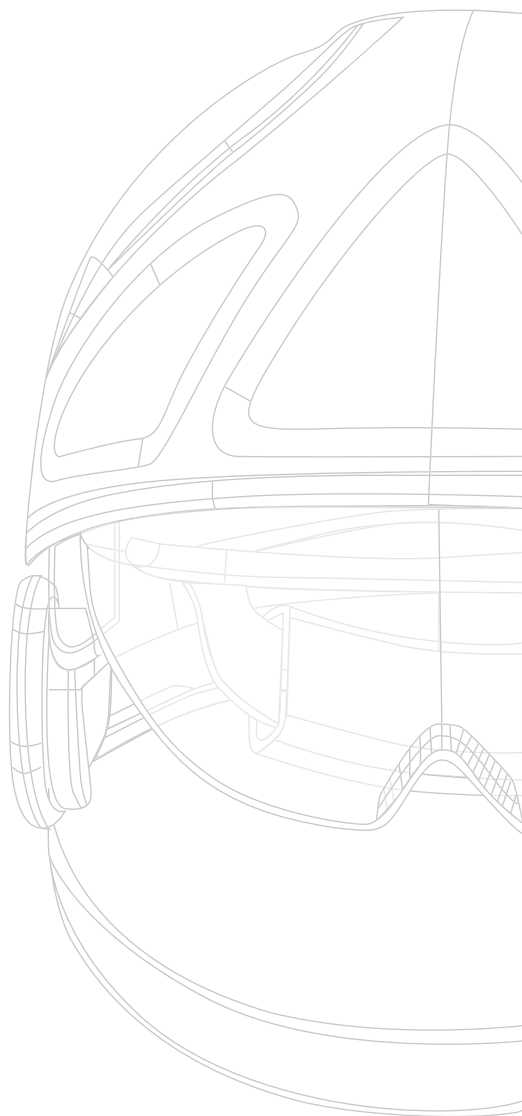

8. CERTIFICATION AND DISTRIBUTORS INFORMATION

a. CERTIFICATION

i. CE and Wheelmark

INSPEC International Ltd. (N.B. No: 0194)
56 Leslie Hough Way, Salford
Gt Manchester, M6 6AJ, UNITED KINGDOM

BSI Group (N.B.#0086)
Kitemark Court, Davy Ave, Knowhill,
Milton Keynes, MK5 8PP,
UNITED KINGDOM

M.E. Industrial Products (Authorized Representative)
41 Ramsey Gardens
Romford, ESSEX
RM3 7NT, UNITED KINGDOM

ii. AS/NZS and NFPA

BSI Group ANZ Pty Ltd.
Suite 2, 123 Whitehorse Road
Balwyn, VIC 3103, AUSTRALIA

b. AUTHORISED DISTRIBUTORS

Please visit our website: www.pacifichelmets.com for up to date details.

9. SUPPLEMENTARY INFORMATION

a. SWEAT PAD CHANGE INSTRUCTIONS

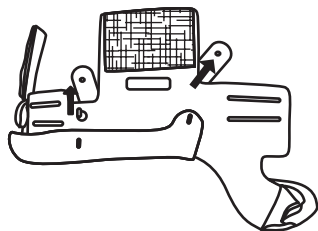

1. Remove front sweat pad from hooks on headband.

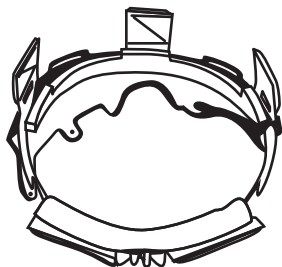

2. Replace front sweat pad on hooks on headband.

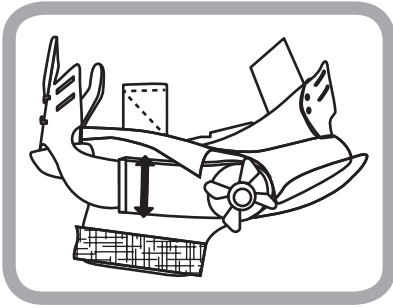

3. Remove rear sweat pad by releasing Velcro.

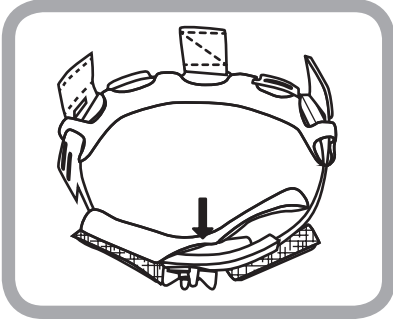

4. Replace sweat pad by attaching Velcro.

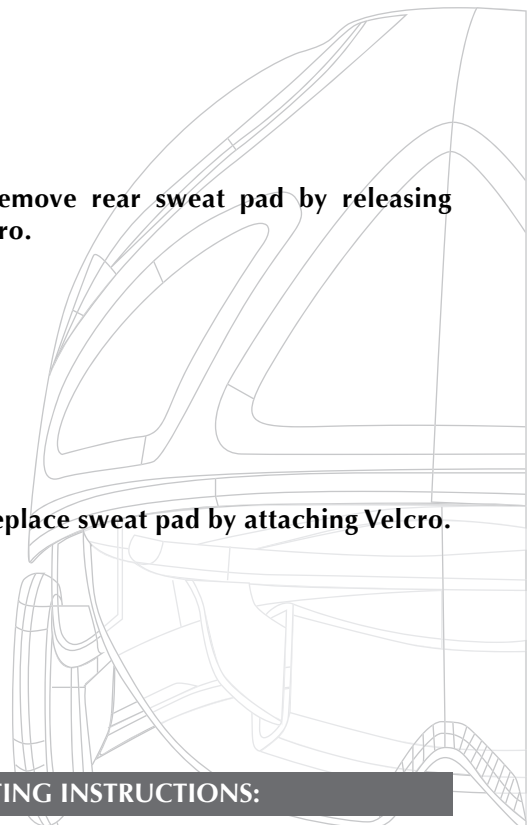

b. BUTTON-HOLE NECK PROTECTOR FITTING INSTRUCTIONS:

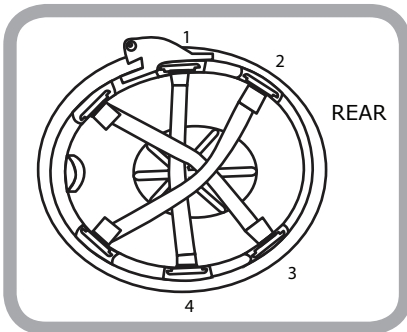

a. Remove rear four (4) cradle ribbon tabs from liner rim.

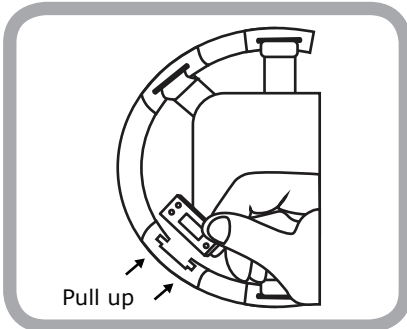

b. To remove ribbon tabs pull up firmly towards you.

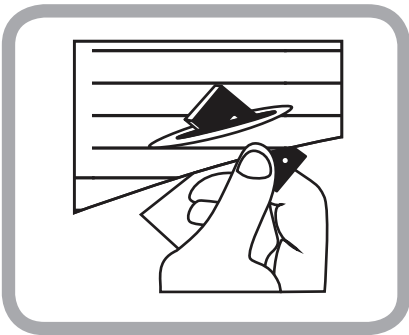

c. Slot cradle ribbon tabs through Neck Protector button holes.

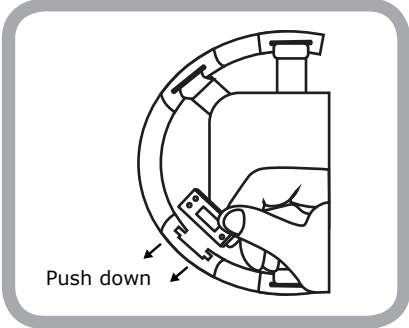

d. Replace cradle ribbon tabs into click clack liner slots. Ensure that tabs are pushed in firmly so they sit flush with the liner rim.

c. VELCRO NECK PROTECTOR FITTING INSTRUCTIONS:

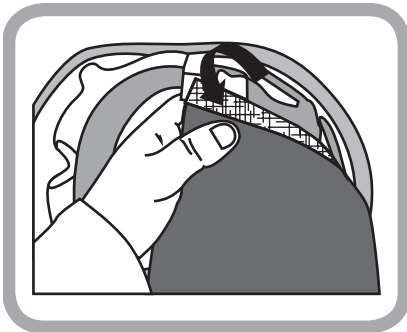

a. Simply pull neck protector away from Velcro strips.

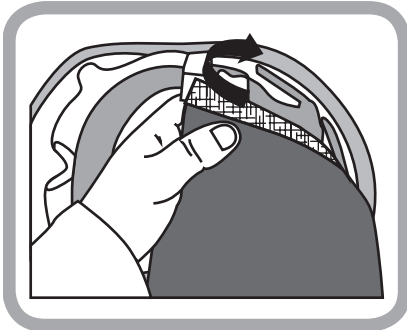

b. Replace neck protector by reattaching Velcro strips. Ensure the neck protector is aligned correctly.

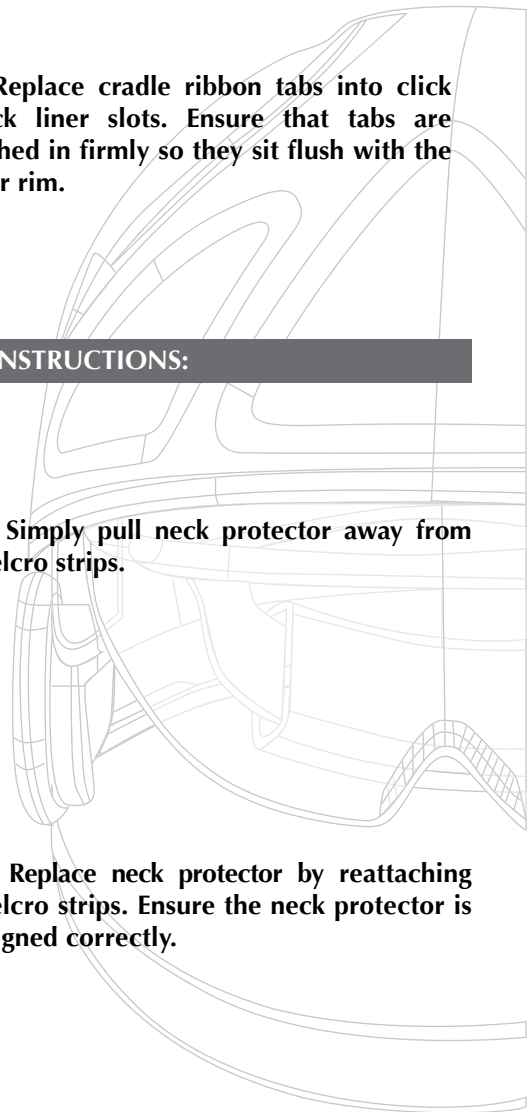

d. FITTING DOWNSIZE PADDING

Front Pad



Rear Pad

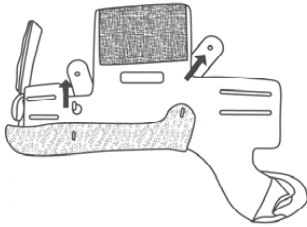

1. Remove front sweat pad from underside hooks on headband

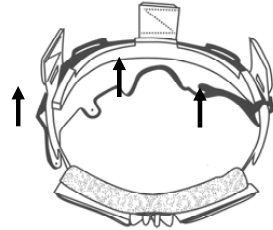

2. Insert downsize pad with contours facing headband legs & replace sweat pad on hooks.

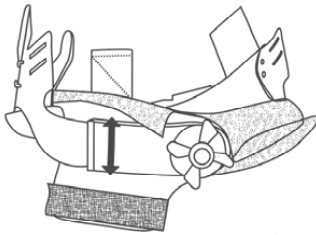

3. Remove rear sweat pad by releasing Velcro

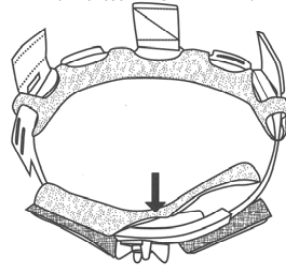

4. Insert rear downsize pad under sweat pad and re-secure Velcro



SAFETY WITHOUT COMPROMISE

**P. O. Box 866, 315 Heads Road,
Wanganui 4501, New Zealand**

Phone: +64 -6- 344 5019

Fax +64 -6- 344 5376

Email: sales@pacifichelmets.com

Website: www.pacifichelmets.com

Distributor Contact Details